

iProjec-V12

Vertical Measuring Profile Projector



Contact us

Mikrosize Precision Instrument Co.,Ltd

A-4035 RuiFeng Business Expo, Wuhu City, China , 241000.

Web: www.mikrosize.com

Email: mikrosize@mikrosize.com



Feature and Application

Vertical projectors have remarkable advantages, with an excellent optical system, where the objective lens provides clear imaging and the magnification ratio is accurate, and the contour measurement error under transmitted light is less than 0.08%; they have extremely high measurement precision with the indicated error of coordinate measurement reaching $(3 + L/200) \mu\text{m}$, the digital display resolution of the X and Y coordinates is 0.0005 mm enabling accurate data reading, the Z-axis is driven by a guide rail making the body stable and durable, and they are equipped with the DP-300 data processing system which is convenient to operate and also supports RS-232 data output.

Product Feature

- High-precision optical system: It is equipped with a high-quality objective lens, which provides clear and sharp imaging. Under transmitted light illumination, the contour measurement error is less than 0.08%, and the magnification ratio is accurate and reliable.
- Precise coordinate measurement: The digital display resolution of the X and Y coordinates reaches 0.0005 mm. The indication error of coordinate measurement is only $(3 + L/200) \mu\text{m}$, where L is the measured length, ensuring high measurement accuracy.
- Stable Z-axis design: The Z-axis lifting adopts the guide rail transmission method, which greatly enhances the stability and durability of the projector body and ensures stability without shaking during measurement.
- Durable workbench: The metal tabletop measures 340×152mm, and the glass tabletop measures 196×96mm. Made of sturdy materials, it can bear various workpieces and is not prone to wear.
- High-quality projection screen: The projection screen has a size of $\Phi 312\text{mm}$, with a usable range of more than $\Phi 300\text{mm}$.
- It is engraved with a crosshair pattern and has a rotation range of 0-360°, which facilitates positioning and multi-angle measurement.
- Reliable lighting component: Both the transmitted light and reflected light use 24V/150W halogen lamps, equipped with forced air cooling. The lighting is stable and the heat dissipation performance is excellent, ensuring a stable measurement environment.

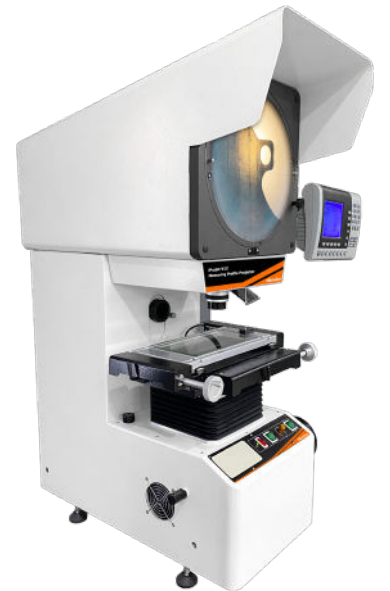

Feature and Application

Product Application

- Mechanical manufacturing: It can accurately measure complex mechanical parts, such as the contours of cams and gears, ensuring the machining accuracy and assembly quality.
- Electronic industry: It can accurately detect the dimensions of tiny electronic components, facilitating the miniaturization and high-precision production of electronic products.
- Mold processing: It is used for the measurement of mold cavities, cores, etc., ensuring the manufacturing precision of molds and improving the service life of molds.
- Metrology and calibration: It provides high-precision measurements for metrology departments, realizes the traceability of measured values, and ensures the accuracy of measurements in the industry.
- Education and scientific research: Universities, colleges, and research institutes can use it for teaching demonstrations and scientific research experiments, assisting in precision measurement research.

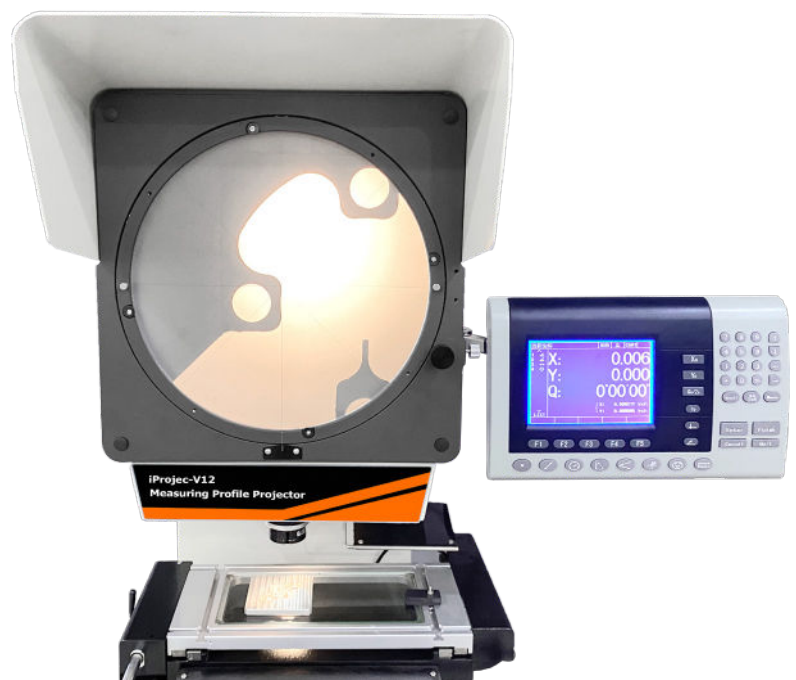

Product Details

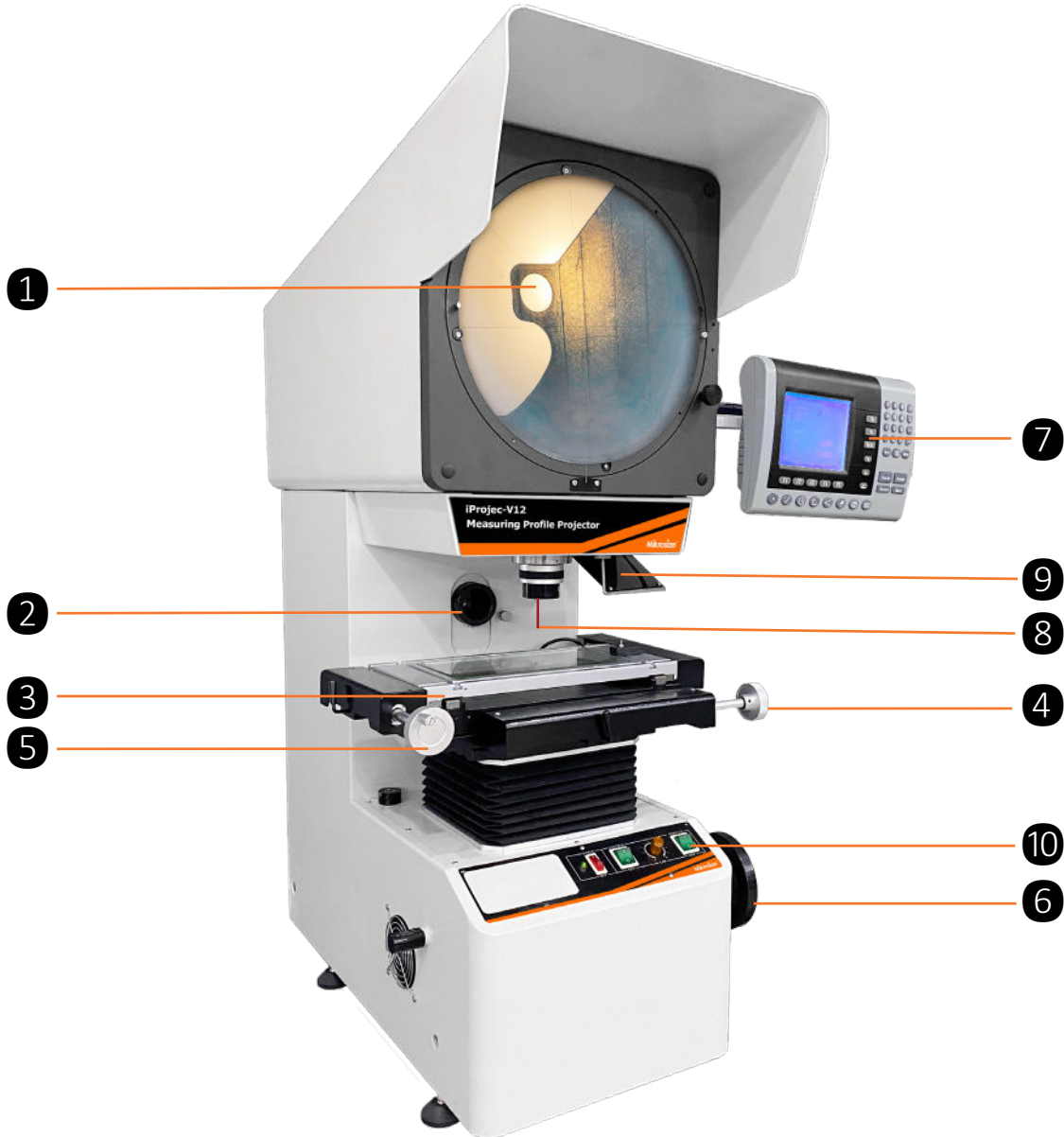

1.Projection Screen

4.Handwheel of the X-axis

6.Handwheel of the Z-axis

8.Objective Lens

2.Light Source

5.Handwheel of the Y-axis

7.DR0300 Digital Readout

9.Light Shield

3.Worktable

10.Switch

Product Details

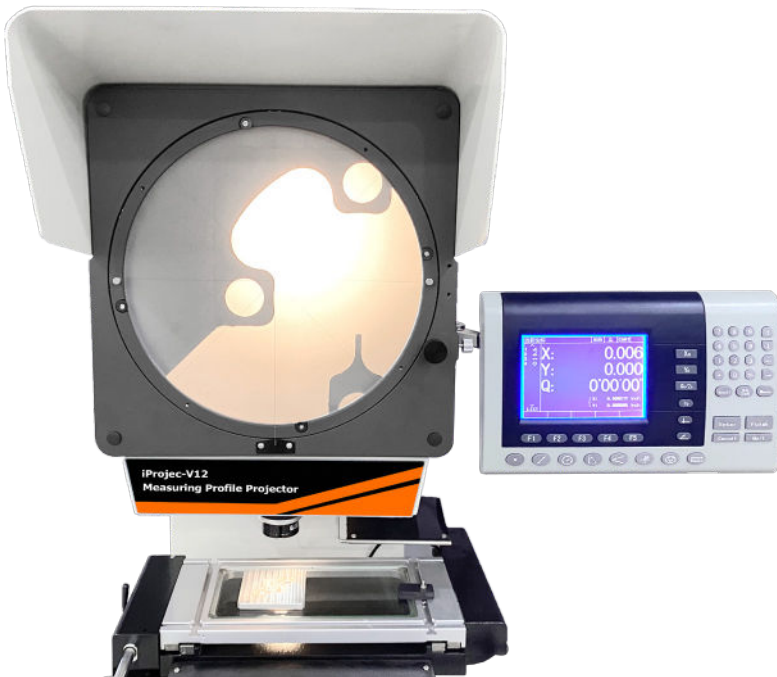

- The projection screen has excellent configuration: With a size of $\Phi 312\text{mm}$ and a usable range of more than $\Phi 300\text{mm}$, it has a rotation range from 0° to 360° . Coupled with the crosshair pattern, it is convenient for observation and measurement from multiple angles.
- It performs excellently in color restoration and can accurately present a rich variety of colors.

- Flexible transmitted light illumination: The intensity of the transmitted light illumination can be continuously adjusted between high and low levels. According to the materials, colors and measurement requirements of different workpieces, the light intensity can be accurately adjusted to obtain clear projection images, which is convenient for precise measurement.
- The reflected light illumination adopts optical fiber transmission, which features a small size and high illuminance, making it convenient for observation and measurement. Halogen-tungsten lamps and other light sources are used to provide light of sufficient intensity, uniformity and stability.
- The light source system is equipped with a forced air cooling device and three axial fans, which can effectively dissipate the heat generated during the operation of the light source, thus extending the service life of the light source.



Product Details

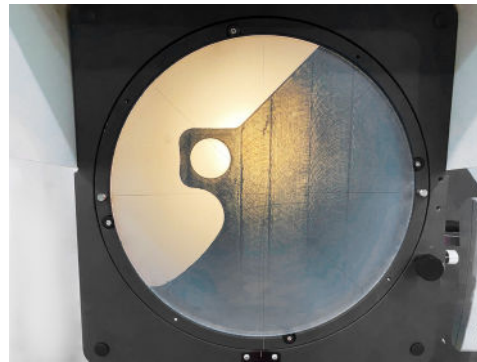

- A surface mirror is included as a standard accessory. With this surface mirror, users can directly observe the surface of the workpiece. Whether it is subtle scratches, wear marks, or detailed features such as the texture structure of the workpiece surface, all can be clearly presented.



- It is equipped with a light shield, which can effectively block the excessive strong light and scattered light generated during the operation of the projector. During the measurement process, it prevents the direct irradiation of strong light on the eyes, reducing the irritation and damage of the light to the eyes.

Product Details

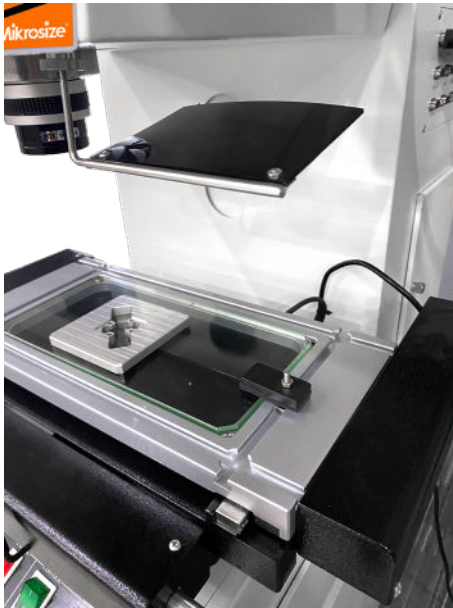

- The handwheel is designed ergonomically, offering a comfortable grip and smooth rotation.
- It has a fine-tuning function. Even for minute position adjustments, it can be easily achieved by slowly rotating the handwheel, meeting the fine-tuning requirements for high-precision measurements.
- It is manufactured with high-quality materials, featuring a sturdy structure and strong wear resistance.
- The digital display resolution of the X and Y coordinates can reach 0.0005mm.

Using Advantage

DRO300 Digital Readout

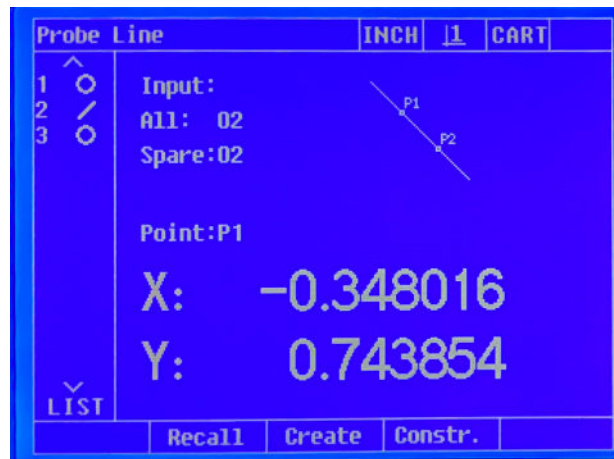
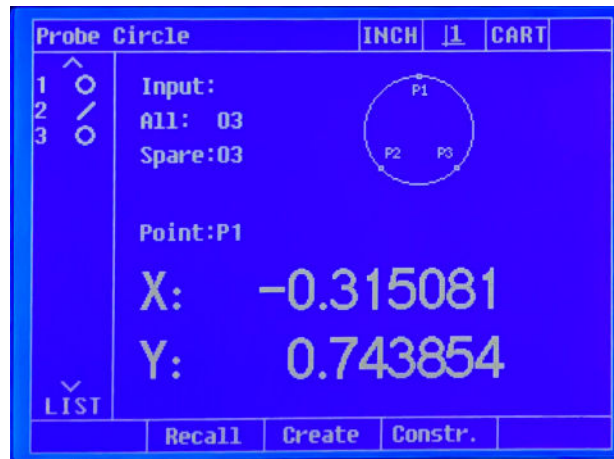

- It adopts advanced electronic counting technology, which can accurately record measurement data. The minimum resolution can reach 0.0005mm, ensuring the high precision of the measurement results.
- The counter is real-time connected to the measurement system, which can instantly display the measurement values. There is no need for manual calculation or reading of complex scales, thus improving the measurement efficiency.
- The counter is equipped with an easy-to-understand operation interface, and the keys are reasonably arranged. Operators can easily perform operations such as resetting to zero, setting values, and switching measurement units, which reduces the operation difficulty.
- It has a data storage function and can save multiple groups of measurement data, making it convenient for users to query and compare historical data at any time.
- It can be connected to external devices such as computers to achieve data transmission and sharing.

Instrument Dimension

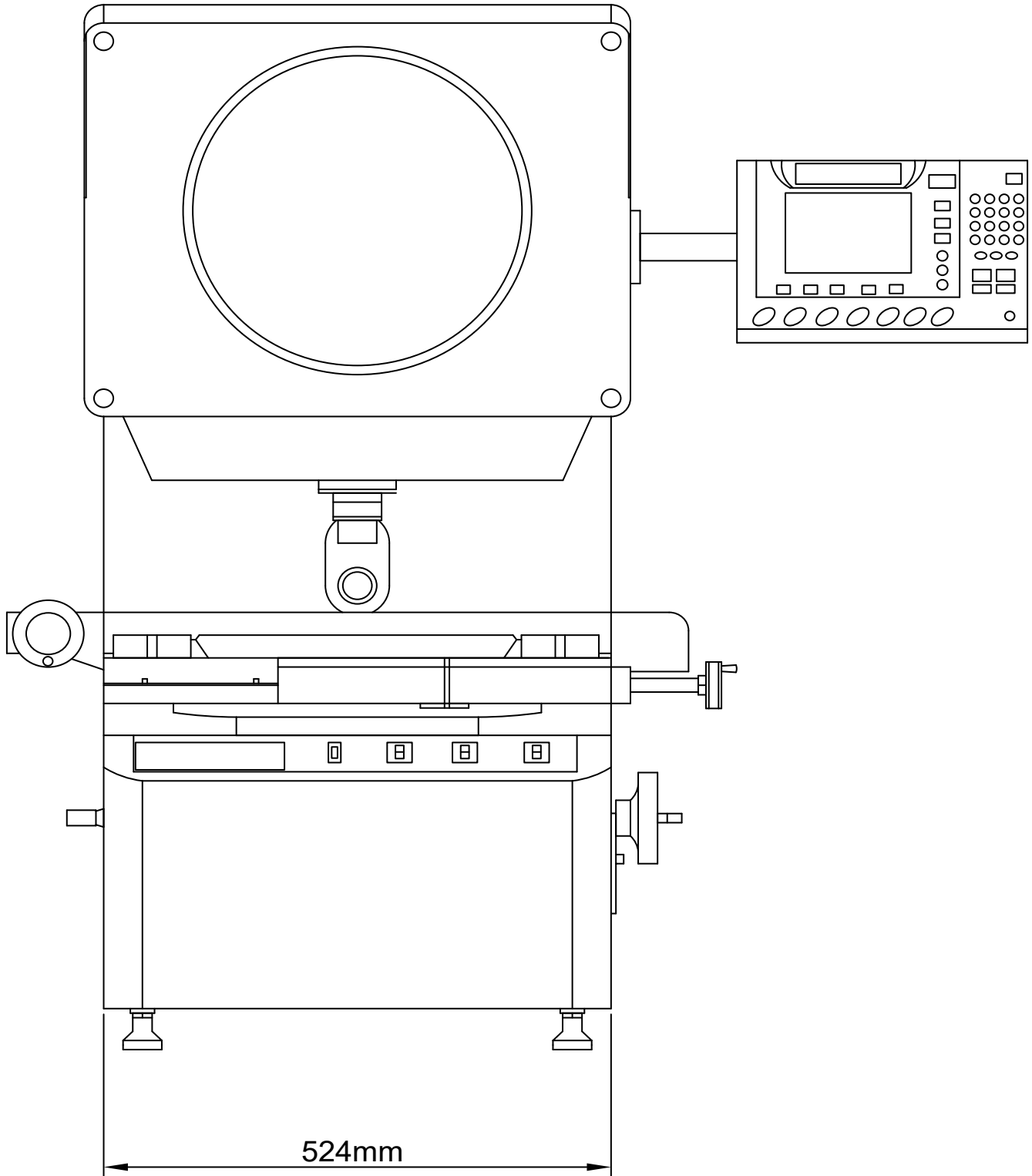

Instrument Dimension

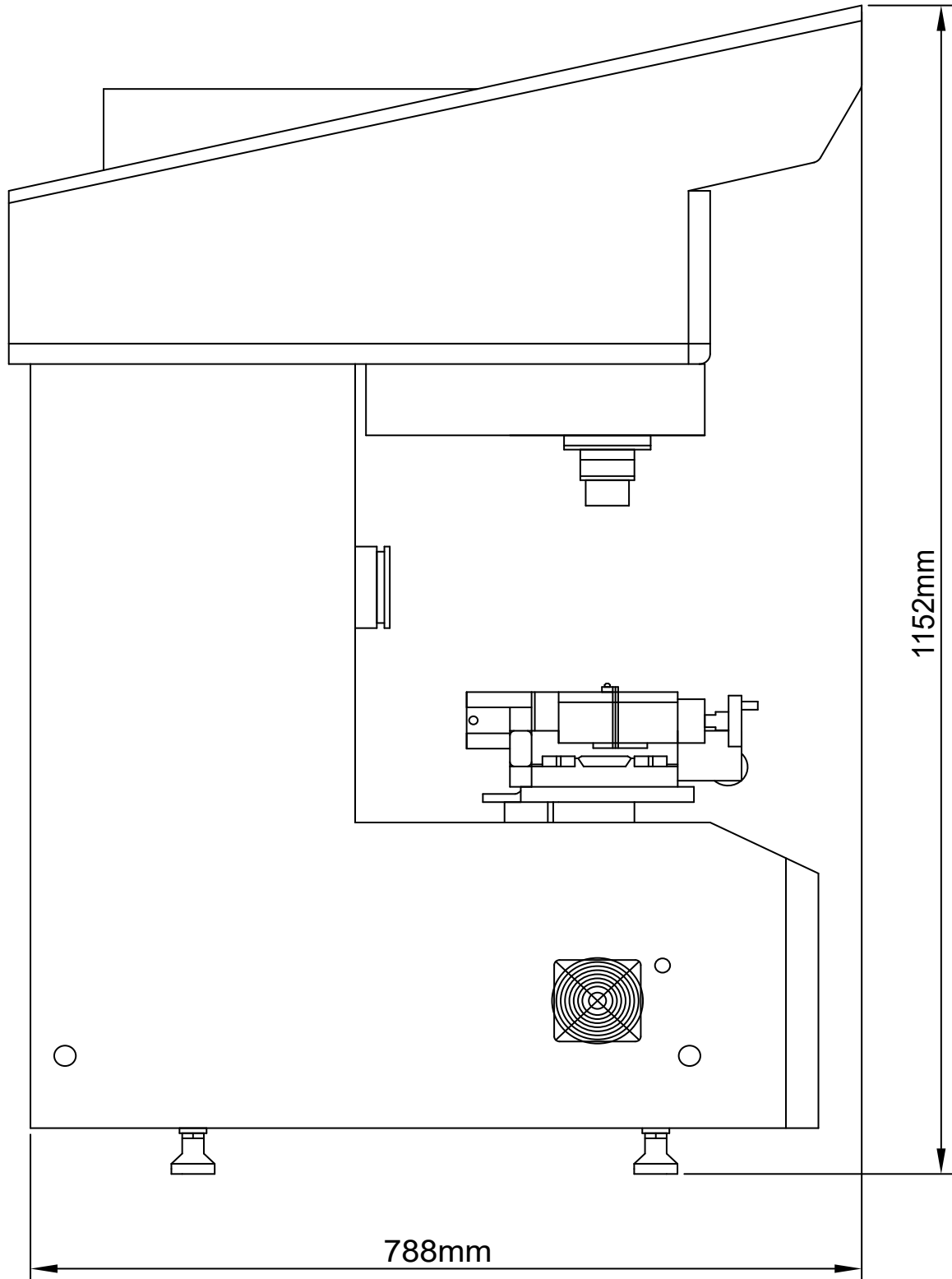

Technical Specification

Model	iProjec-V12-1550	iProjec-V12-2010	iProjec-V12-2515
X,Y-axis Travel(mm)	150*50	200*100	250*150
Z-Axis Travel(mm)	100mm(Focusing)		
Precision	X/Y-axis: $\leq 3+L/200(\mu\text{m})$		
Projector Screen Size(mm)	$\Phi 312\text{mm}$, Used range $> \Phi 300\text{mm}$ (with the meter line)		
Projector Screen Rotation Range	$0^{\circ} \sim 360^{\circ}$		
Rotation Angle Resolution	1' or 0.01°		
Magnification	10X(Standard), 20x, 50X, 100X(Optional)		
Power	110V/220V(AC), 50/60HZ, Total power $\approx 400\text{w}$		
Data Processing System	DP300, supporting English, Chinese, can be used to measure and gather the data of 2D dimensions of point, line.-circle, angle, distance and so on at ease.		
Cold	Forced air cooling		
Illumination	The illumination of transmission and reflection: 24V/150W-halogen lamp		
Dimension	788*524*1152	770*550*1120	770*550*1120
Net Weight	122kg	125kg	162kg

Standard Delivery

Name	Qty	Photo
8A fuse	5pcs	/
Halogen Lamps (64640)	2pcs	/
Halogen Lamps (13629)	1pc	/
Power Cable	1pc	/
Rotary Fastening Plug	4pcs	/
Foot Switch	1pc	/
10X Objective lens	1pc	/
Machine Instruction Manual	1pc	/
DRO300 Instruction Manual	1pc	/
Dust-proof Cover	1pc	/
Surface Lens	1pc	/
Light Shield	1pc	/

Optional Delivery

Optional

Objective lens(20X 50X 100X)

Rotary table

Arc film (with film clips)

Glass line ruler

V-groove Fixture

Edge finder

Measuring Software

Working Cupboard

Mikrosize Precision Instrument Co.,Ltd

Add: A-4035 RuiFeng Business Expo , Wuhu City, China , 241000.

Tel: 0553-2836939 Fax:0553-2836938 Web: www.mikrosize.com

