

iProjec-H12/H16/H24 Horizontal Profile Projector



Contact us

Mikrosize Precision Instrument Co.,Ltd

A-4035 RuiFeng Business Expo, Wuhu City, China , 241000.

Web: www.mikrosize.com

Email: mikrosize@mikrosize.com



Feature and Application

The projector has remarkable advantages. Its structure has strong versatility, with an aesthetically pleasing appearance and convenient operation. The lifting transmission of the worktable adopts imported V-shaped linear guide rails, providing a smooth and comfortable experience. The optical system is of high quality, with the objective lens producing clear images and accurate magnification ratios. In terms of illumination, the intensity of the transmitted illumination can be continuously adjusted, and the reflected illumination uses optical fiber transmission, which has a high illuminance and is easy to use. The worktable is processed from aviation aluminum alloy, offering a large measurement range while being lightweight. The instrument features high measurement accuracy and stable performance, and it can also measure the dimensions and parts that are difficult to measure with a vertical projector.

Product Feature

- High-precision optical system: Equipped with high-quality objective lenses, it can produce sharp and clear images, and the magnification ratio is accurate, ensuring the accuracy of dimensional measurement and meeting the requirements of precise measurement.
- Precision worktable: Processed from aviation aluminum alloy, it has a large measurement range and is lightweight. The digital display resolution of the X and Y coordinates reaches 0.0005mm, and the positioning accuracy is extremely high.
- Stable guide rail transmission: The lifting transmission of the worktable adopts imported V-shaped linear guide rails, which run smoothly, reduce vibration deviation, and ensure the stability and accuracy during the measurement process.
- High-quality lighting components: The intensity of the transmitted illumination can be continuously adjusted. The reflected illumination utilizes optical fiber transmission, featuring high and stable illuminance, which provides a clear field of vision for precise measurement.
- Sturdy and durable structure: The overall structure has strong versatility, a reasonable design, and high-quality materials. It is resistant to interference and wear, and can maintain high precision even after long-term use.
- Advanced digital display system: The coordinate indication value error is $\leq 3+L/200$. Equipped with an advanced digital display system, the readings are intuitive and accurate, effectively improving the measurement accuracy and efficiency.



Feature and Application

Product Application

- Mechanical manufacturing: It can accurately measure the contours of complex mechanical parts and control the machining accuracy and quality.
- Electronics industry: It can detect the dimensions of tiny electronic components, ensuring the precision in the production of electronic products.
- Instrument production: It can measure the components of instruments efficiently, ensuring the stable and reliable assembly and performance of the instruments.
- Mold processing: It is used for the measurement of key parts such as mold cavities, improving the precision of mold manufacturing.
- Metrological verification: It provides a high - precision measurement basis for metrological departments, ensuring the accurate transfer of measurement values.

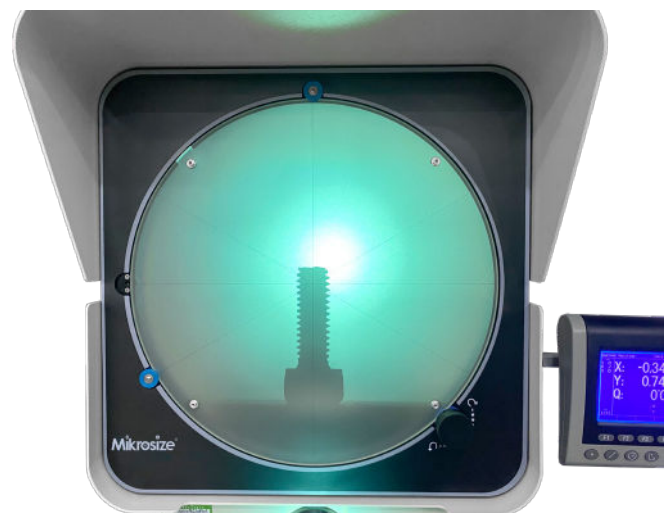

Product Details



1.Projection Screen

2.Light Source

3.Working Worktable

4.Handwheel of The X-Axis 5.Handwheel of The Y-Axis 6.Handwheel of the Z-axis

7.Auxiliary light source 8.DR0300 Digital Readout 9.Switch 10.Angle scale

Product Details

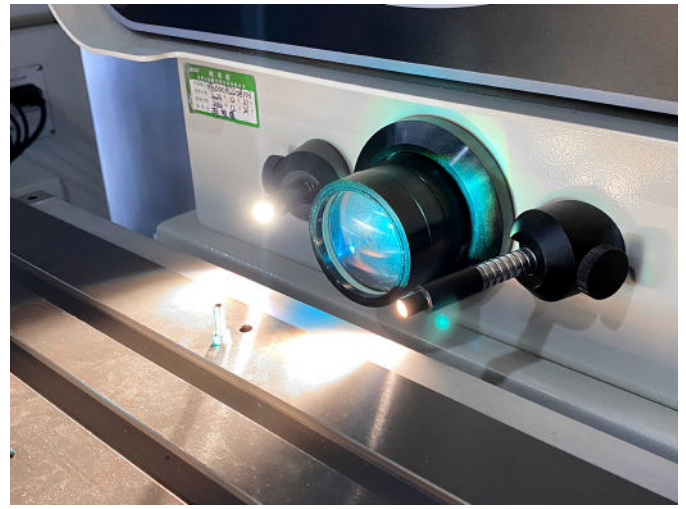
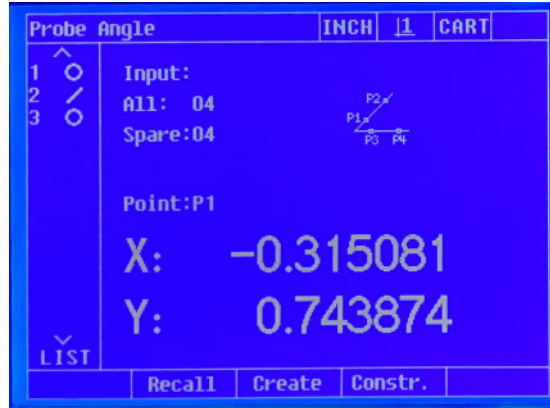
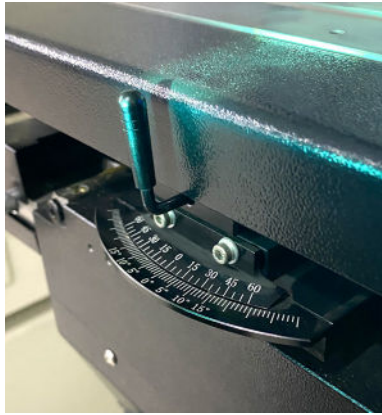

Instrument Structure

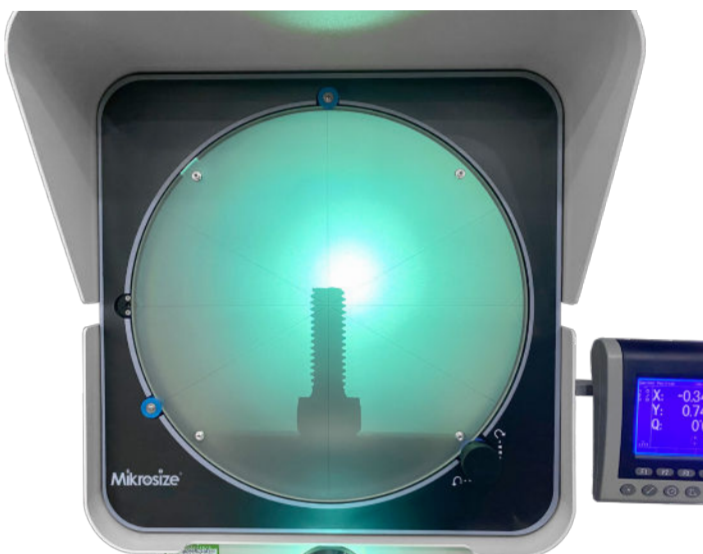

- A large 16-inch projection screen (12 or 24 inches are optional) provides clear imaging, enabling clear presentation of even the slightest flaws and textures.
- It performs excellently in color reproduction and can accurately present a rich palette of colors.

Product Details

Instrument Structure

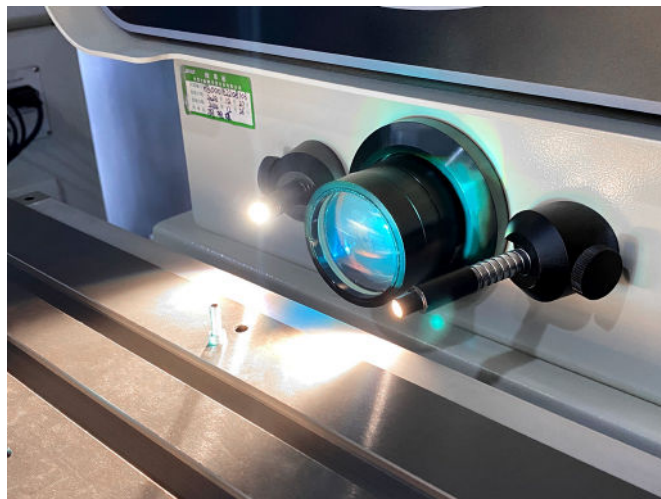
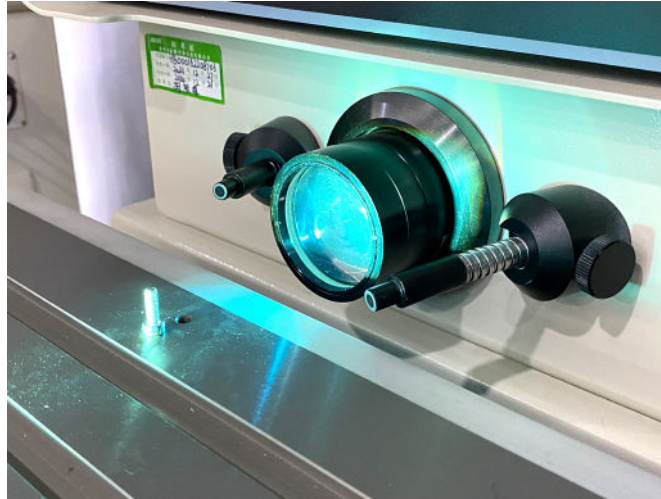

- Flexible transmitted illumination: The intensity of the transmitted illumination can be continuously adjusted between high and low levels. According to the materials, colors, and measurement requirements of different workpieces, the light intensity can be precisely adjusted to obtain clear projection images, facilitating accurate measurement.
- The reflected illumination adopts optical fiber transmission, which is characterized by a small size and high illuminance, making it convenient for observation and measurement.
- Halogen tungsten lamps and other light sources are used to provide light of sufficient intensity, uniformity, and stability.
- The light source system is equipped with a forced air - cooling device consisting of three axial - flow fans. This effectively reduces the heat generated during the operation of the light source and extends its service life.

Product Details

Instrument Structure

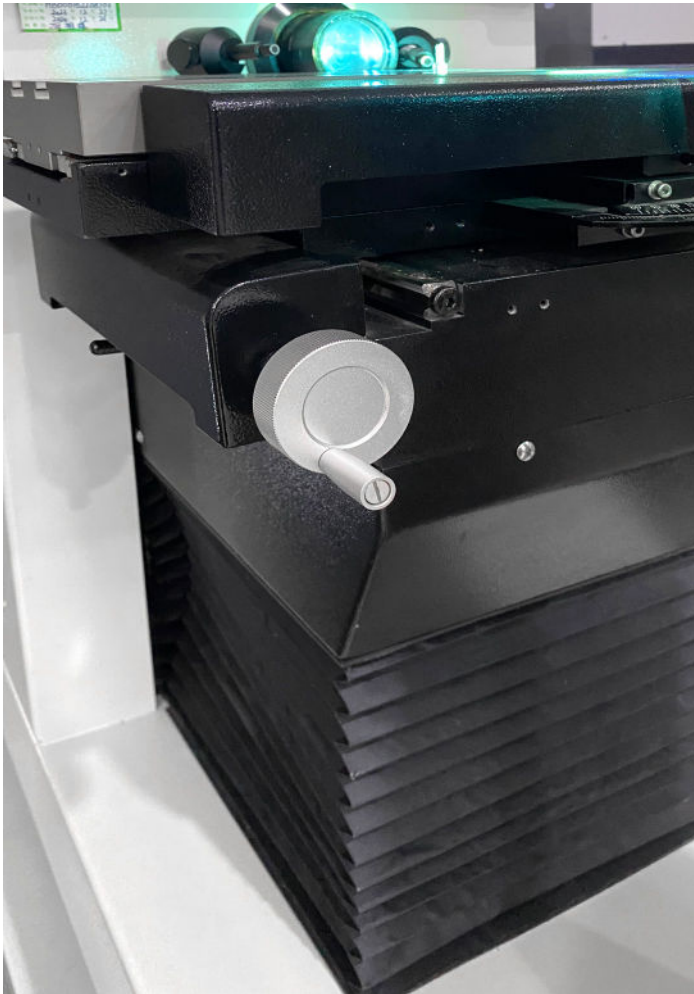

- The handwheel is designed ergonomically, offering a comfortable grip and smooth rotation.
- It has a fine adjustment function. Even for minute position adjustments, they can be easily achieved by slowly turning the handwheel, meeting the fine adjustment requirements for high-precision measurements.
- It is manufactured with high-quality materials, featuring a sturdy structure and strong wear resistance.
- The digital display resolution of the X and Y coordinates can reach 0.0005mm.

Using Advantage

DRO300 Digital Readout

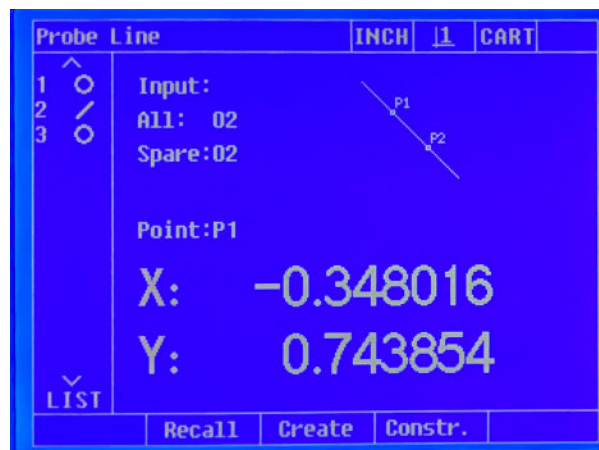
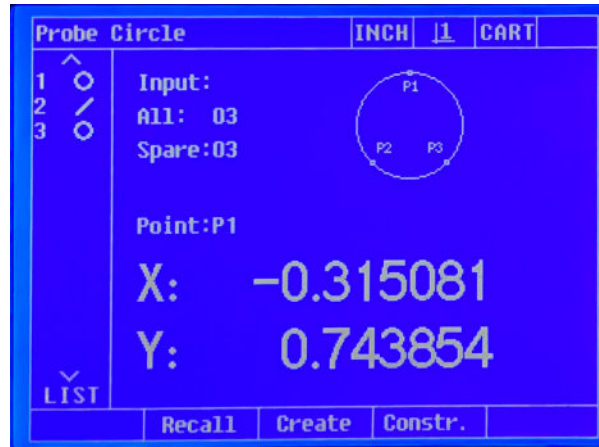

- It adopts advanced electronic counting technology, which can accurately record measurement data. The minimum resolution can reach 0.0005mm, ensuring the high precision of the measurement results.
- The counter is real-time connected to the measurement system, which can instantly display the measurement values. There is no need for manual calculation or reading of complex scales, thus improving the measurement efficiency.
- The counter is equipped with an easy-to-understand operation interface, and the keys are reasonably arranged. Operators can easily perform operations such as resetting to zero, setting values, and switching measurement units, which reduces the operation difficulty.
- It has a data storage function and can save multiple groups of measurement data, making it convenient for users to query and compare historical data at any time.
- It can be connected to external devices such as computers to achieve data transmission and sharing.

Instrument Dimension

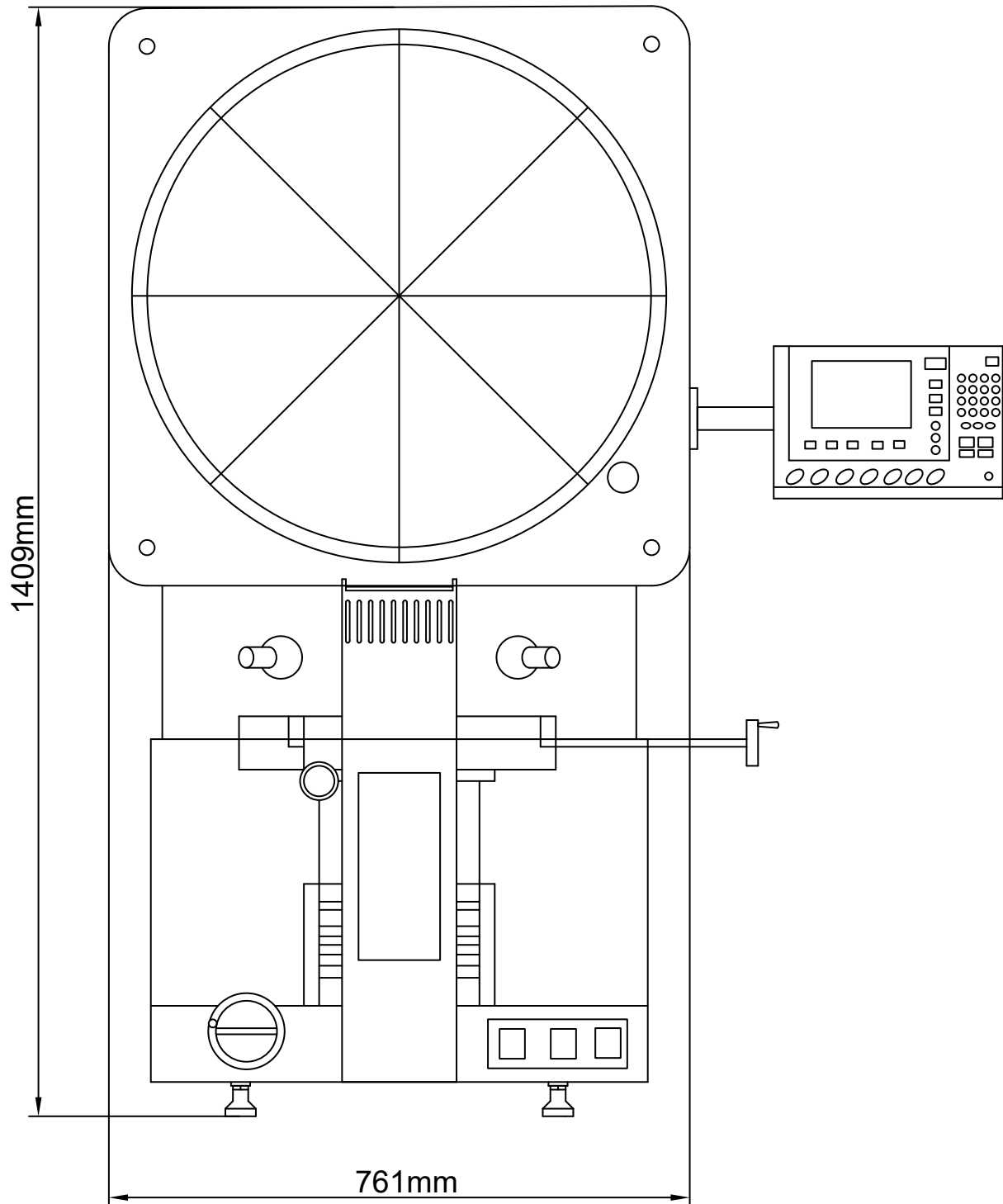

iProjec-H12

Instrument Dimension

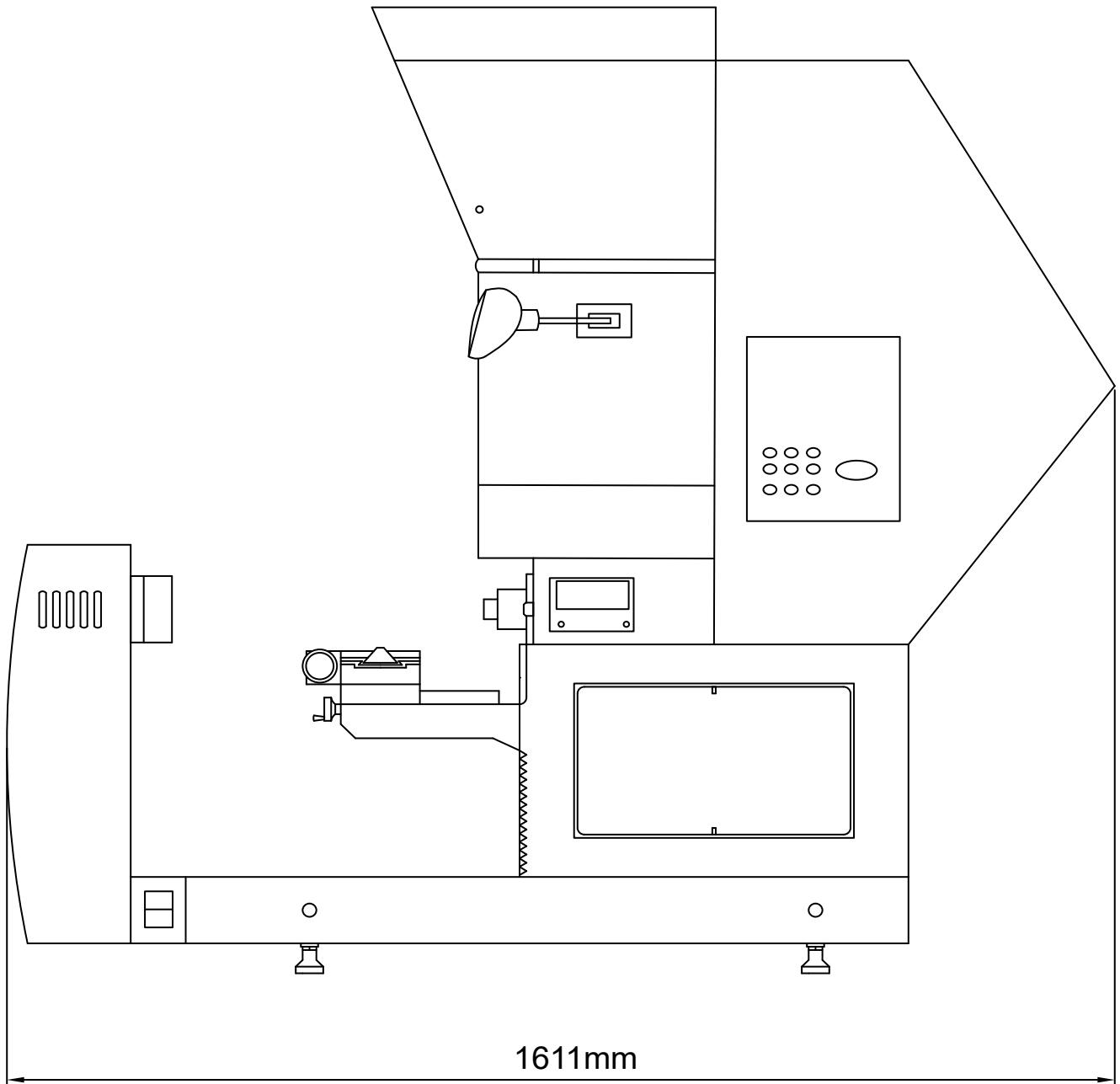

iProjec-H12

Technical Specification

Model	iProjec-H12	iProjec-H12	iProjec-H24
X,Z-axis Travel(mm)	200*100	300*150	300*150
Y-axis Travel(mm)	75(Focusing)	125(Focusing)	125(Focusing)
Precision	X/Y-axis $\leq 3+L/200(\mu\text{m})$		
Projector Screen Size(mm)	$\Phi 330$	$\Phi 425$	$\Phi 615$
Projector Screen Rotation Range	0-360°		
Rotation Angle Resolution	1' or 0.01°		
Magnification	10X(Standard),20X、 50X、 100X(Optional)		
Power Source	110V/220V (AC),50/60HZ,Total 400W		
Digital Readout	Supports English, can be used for measuring and collecting two-dimensional data such as points, lines, circles, angles, distances, etc., and is easy to operate		
Cooling Method	Forced air cooling (3-axis fan)		
Illumination	Transmission and reflection lighting: 24V/150W halogen lamp		
Machine Size(mm)	1114*756*9964	1360*580*1170	1611*761*1409
Instrument Accessory	Mini-printer(Standard),Measuring Software(Optional)		

Standard Delivery

Name	Qty	Photo
8A fuse	5pcs	/
Halogen Lamps (64640)	2pcs	/
Halogen Lamps (13629)	1pc	/
Power Cable	1pc	/
Rotary Fastening Plug	4pcs	/
Foot Switch	1pc	/
10X Objective lens	1pc	/
Instruction Manual	1pc	/
DRO300 Instruction Manual	1pc	/
Dust-proof Cover	1pc	/

